



OPTIMUM STICK BLENDER SET

Blend, Whisk, Chop, Mash, and More!



USER MANUAL

CONTENTS

WELCOME TO YOUR OPTIMUM STICK BLENDER	1
SAFETY FIRST	2
GETTING TO KNOW YOUR OPTIMUM STICK BLENDER	5
ATTACHMENTS GUIDE	6
HOW TO USE YOUR OPTIMUM STICK BLENDER: USING THE HAND BLENDER	7
HOW TO USE YOUR OPTIMUM STICK BLENDER: USING THE CHOPPER BOWL	9
HOW TO USE YOUR OPTIMUM STICK BLENDER: USING THE DOUBLE BEATER	12
HOW TO USE YOUR OPTIMUM STICK BLENDER: USING THE POTATO MASHER	14
HOW TO USE YOUR OPTIMUM STICK BLENDER: USING THE 1,25L CHOPPER	16
OPERATION GUIDE	17
CLEANING	18
TROUBLESHOOTING	19
TECHNICAL SPECIFICATIONS	20
WARRANTY	21
CONTACT US	22

WELCOME TO YOUR OPTIMUM STICK BLENDER

Welcome to your new Optimum Stick blender, a powerhouse of versatility that's set to revolutionize your kitchen. Whether you're whipping up a quick smoothie or putting together a velvety soup, **this all-in-one appliance is designed to deliver the best flavors and textures for all your meals.**

Your Optimum Stick Blender comes with a wide range of attachments tailored to meet all your cooking needs. The hand blender attachment is perfect for creating everything from silky soups to smooth sauces. The chopper attachment, complete with its own bowl, can handle all your chopping, dicing and mincing in a flash – no more tears over onions! The double beater attachment will make sure your batters, creams and meringues are whipped to perfection. And when it comes to mashed potatoes, the potato masher attachment delivers fluffy, lump-free results that are sure to impress.

Whether you're an experienced cook or just starting out, **the Optimum Stick Blender will be your go-to kitchen companion.** Its ergonomic design and powerful performance make it easy to switch between tasks, allowing you to create even more delicious meals. So let's dive in and discover all the amazing things your new Optimum Stick Blender can do.

For your safety and to achieve the best results, take a moment to read through these instructions in the user manual.

SAFETY FIRST

Before using the Optimum Stick Blender, please read these instructions thoroughly. Be sure to keep the instructions, warranty, receipt, original box and packaging. If you pass the Optimum Stick Blender on to someone else, remember to include this user manual and store these instructions for future reference.

1. The Optimum Stick Blender is designed exclusively for private domestic use and for the envisaged purpose. This appliance is not fit for commercial use.
2. Check if the voltage indicated on the Optimum Stick Blender corresponds to the local mains voltage before you connect the appliance.
3. Appliances can be dangerous if they are used incorrectly. Please ensure that anyone who uses the Optimum Stick Blender clearly understands how to operate it safely to avoid potential hazards.
4. Your Optimum Stick Blender is not a toy. Do not allow children to use it. Keep it and the cord that comes with it out of their reach. Care should be taken when using it near children.
5. Switch off your Optimum Stick Blender and disconnect it from any power supply before you change the attachments or handle any moving parts.
6. Do not insert the mains plug of the Optimum Stick Blender into the power socket without having installed all the necessary attachments.
7. When cleaning or putting it away, or if the Optimum Stick Blender is not being used, switch off the appliance and always pull out the plug from the socket, not by the cable, and remove attached accessories.
8. Do not operate the Optimum Stick Blender without supervision. If you should leave the workplace, always switch the appliance off and remove the plug from the socket. Pull the plug and not the cord.
9. Check the Optimum Stick Blender and the cord for damage on a regular basis. Do not use the appliance if it is damaged. Do not try to repair the appliance on your own. Always contact an authorised technician. If the cord is damaged, it must be replaced by the manufacturer, its service agent or similarly qualified persons in order to avoid a hazard.
10. Any damage to components – including the main body, hand blender attachments, chopper attachments, double beater attachments, mashed potato attachments can make your appliance less safe to use. Regularly check all components for damage and if you find something wrong, please stop using the appliance and contact the after sales service centre.
11. Accessories, other than those supplied with the Optimum Stick Blender, should not be used when operating the appliance. Misuse may damage the appliance and void your warranty.
12. Do not use the Optimum Stick Blender outdoors.
13. Keep the Optimum Stick Blender away from sources of heat, direct sunlight, humidity and sharp edges.
14. Do not use the Optimum Stick Blender with wet hands, never dip the motor unit into any liquid. If the appliance is humid or wet, unplug it immediately to avoid electrical shock.
15. Thoroughly clean the parts that will come into contact with food before you use the Optimum Stick Blender for the first time.
16. Always store the Optimum Stock Blender in its storage unit, with the accessories stored alongside it on a flat, dry and clean surface.
17. Do not let the cord hang over the edge of a table or counter or touch hot surfaces.

SAFETY FIRST

18. Don't use any attachment and the Optimum Stick Blender if it has been damaged. You should contact the after sales service centre.
19. Dropping your Optimum Stick Blender or allowing it to fall can seriously damage it. Please place it on a stable, flat, heat-resistant surface like a bench or table, and ensure that it is at a safe distance from the edge to avoid falling.
20. If your Optimum Stick Blender stops unexpectedly or appears to malfunction, switch off the power supply, unplug it from the mains and stop using it immediately. Seek professional advice from the manufacturer, its service agent or a similarly qualified person to identify the fault and make any repairs.
21. In order to ensure your children's safety, please keep all packaging, plastic bags, boxes, polystyrene out of their reach. **CAUTION:** Do not allow small children to play with the foil as there is a danger of suffocation.
22. The Optimum Stick Blender can be used by personal with reduced physical, sensory or mental capabilities or with a lack of experience and knowledge if they have been given supervision or instruction concerning the use of the appliance in a safe way and if they understand the hazards involved.
23. Do not insert anything into the Optimum Stick Blender when it is working.
24. **CAUTION:** Ensure that the Optimum Stick Blender is switched off before removing any attachment from the motor unit.
25. Avoid contacting moving parts. Keep hands, hair, clothing, as well as spatulas and other utensils away from the Optimum Stick Blender during operation to prevent injury and damage to the appliance.
26. Do not operate the Optimum Stick Blender unattended or near the edge of the work surface.
27. Do not place hands, fingers or utensils in the vessel the Optimum Stick Blender is operating in unless the appliance is unplugged and the motor has come to a complete stop.
28. To avoid personal injury never use hands or fingers to move ingredients in the vessel whilst the Optimum Stick Blender is running.
29. Should a scraper or other object drop into the vessel, turn the motor off and remove it to avoid personal injury and damage to the Optimum Stick Blender.
30. The use of attachments not recommended by Optimum may cause fire, electrical shock or injury.
31. Before using, make sure the attachment is locked into position and secured to the motor unit.
32. Do not use an extension cord.
33. When using the Optimum Stick Blender, blend soft foods for up to 1 minute making sure not to exceed three cycles per use.
34. Be certain any attachment is secure prior to using the Optimum Stick Blender to avoid any possibility of the attachment falling into the vessel during mixing.
35. Use the Optimum Stick Blender only for its intended function.
36. Use only genuine Optimum spare parts.
37. The blades on the Optimum Stick Blender attachments are very sharp. Handle with care.
38. Do not blend hot or boiling liquids.
39. All attachments, including the chopping bowl, are not microwave safe.

SAFETY FIRST

40. To minimize the risk of injury, always ensure that the cutting blade attachment is secured in the chopping bowl by placing the chopping blade on the centre shaft in the middle of the chopping bowl, before attaching it to the motor unit.
41. Make sure the chopper lid is securely locked in place before operating the Optimum Stick Blender.
42. Handle the sharp cutting blades with care when emptying the bowl and during cleaning.



ELECTRICAL REQUIREMENTS: Your Optimum Stick Blender, operates on a regular 220-240 volt A.C., 50 hertz house current. The wattage rating is determined by using the attachment that draws the greatest power. Other recommended attachments may draw significantly less power.



IMPORTANT: Failure to follow these safety instructions and warning could result in serious injury. Additionally, misusing your Optimum Stick Blender may cause damage and void your warranty.

GETTING TO KNOW YOUR OPTIMUM STICK BLENDER

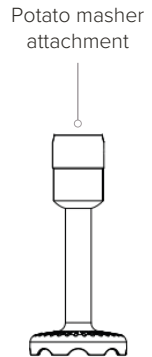
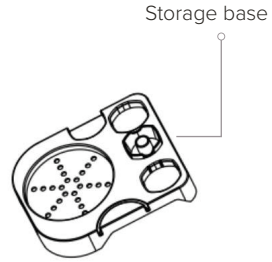
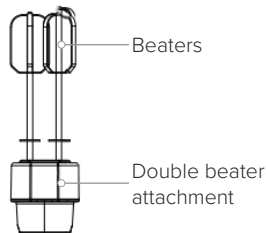
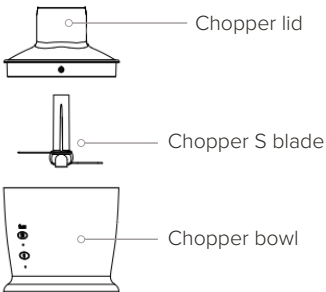
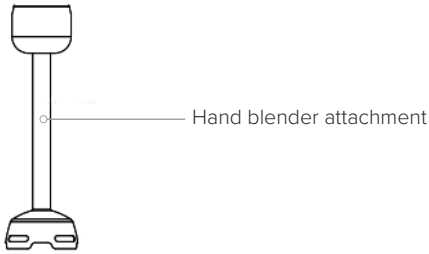
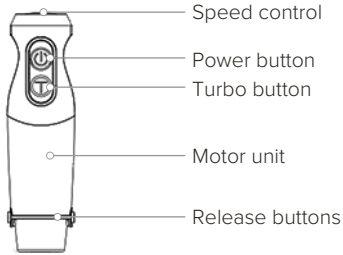
PARTS AND ACCESSORIES

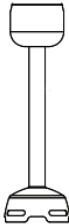

ATTACHMENTS GUIDE

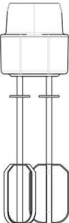
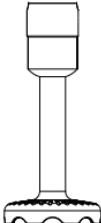
ATTACHMENTS	BEST USED FOR
<p data-bbox="132 448 262 469">Hand blender</p>  A line drawing of a hand blender attachment, consisting of a long, thin shaft with a small motor housing at the top and a wider base at the bottom.	<p data-bbox="547 421 975 528">Blending baby foods, cooked meats, cooked veggies, dips, liquefying fruits and vegetables, making milkshakes, sauces, smoothies and soups.</p>
<p data-bbox="154 719 239 740">Chopper</p>  A line drawing of a chopper attachment, which is a square-shaped container with a lid and a central vertical shaft with a chopping blade at the bottom.	<p data-bbox="547 683 919 762">Chopping breadcrumbs, cheeses, eggs, fruits, herbs, meats, and veggies (for example onions).</p>
<p data-bbox="161 954 232 1002">Double beater</p>  A line drawing of a double beater attachment, featuring a central shaft with two large, rounded beaters extending from the bottom.	<p data-bbox="538 954 978 1002">Whipping batters, cream, egg whites, mayonnaise, mousses, sauces and vinaigrettes.</p>
<p data-bbox="161 1209 232 1257">Potato masher</p>  A line drawing of a potato masher attachment, which is a long shaft with a motor housing at the top and a wide, flat base with a textured surface for mashing.	<p data-bbox="547 1187 956 1235">Making smooth, lump-free mashed potatoes and other mashed vegetables.</p>

HOW TO USE YOUR OPTIMUM STICK BLENDER

USING THE HAND BLENDER

1. Insert the hand blender attachment into the motor unit and lock it into place.

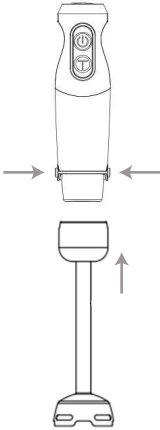

2. Plug the power cord into an outlet and turn it on.

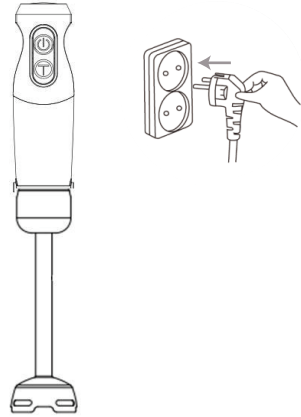

3. Use the speed control to select a speed from 1 to 5 depending on your ingredients.

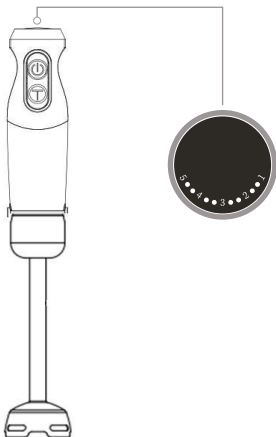

4. Put the blender attachment into the bowl, then press the power button to start blending.

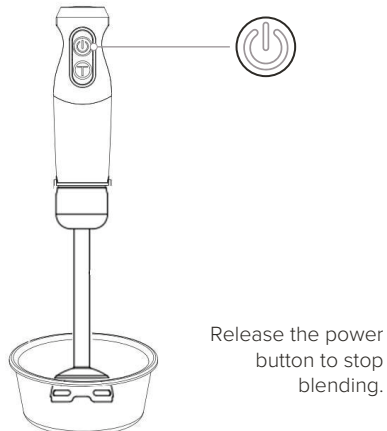

HOW TO USE YOUR OPTIMUM STICK BLENDER

USING THE HAND BLENDER

- 5.** Unplug the power cord after use and before removing or changing attachments.

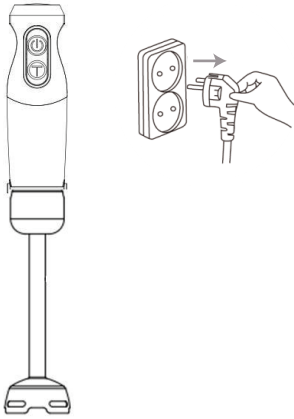

- 6.** Press the release buttons to detach the hand blender attachment from the motor unit.

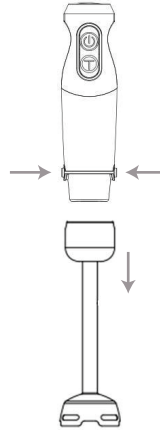

IMPORTANT: Do not submerge past the blending attachment stem. Avoid immersing the motor unit in mixtures and liquids.

HOW TO USE YOUR OPTIMUM STICK BLENDER

USING THE CHOPPER BOWL

1. Always place the chopper bowl on a non-slip surface.

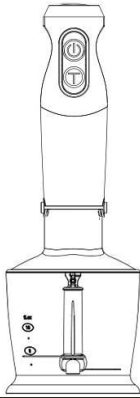

2. Position the chopper S blade onto the centre shaft of the chopper bowl. Press down to lock the blade in place.

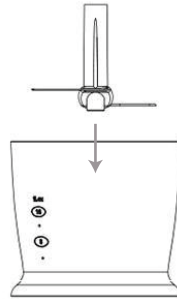

3. Add ingredients to the chopper bowl.

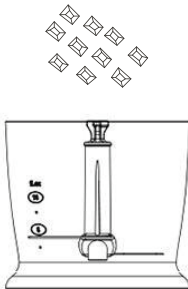

4. To secure the chopper lid onto the chopper bowl, you have to turn it clockwise to secure it into place. It clicks into place once ready.

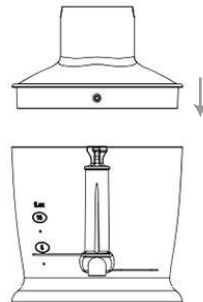

HOW TO USE YOUR OPTIMUM STICK BLENDER

USING THE CHOPPER BOWL

5. Position the motor unit on the chopper bowl lid until it locks into place.

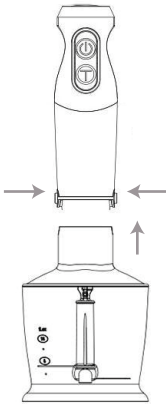

6. Plug the power cord into an outlet and turn it on.

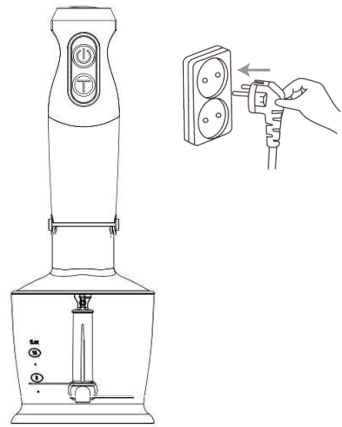

7. Use the speed control to select a speed from 1 to 5 depending on your ingredients.

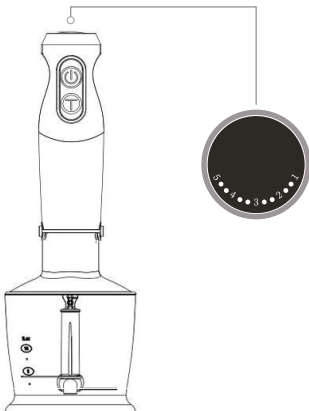

8. Press the power button to start the chopper.

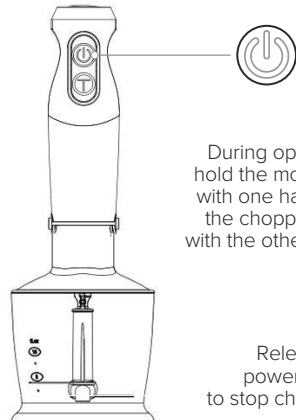

HOW TO USE YOUR OPTIMUM STICK BLENDER

USING THE CHOPPER BOWL

9. After use, unplug the motor unit and press the release buttons to detach the motor unit.

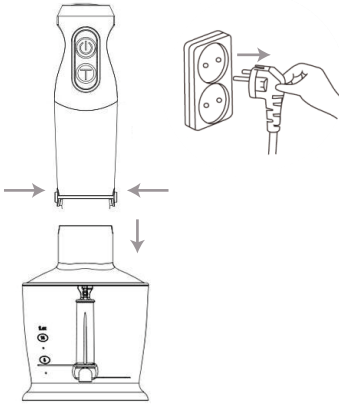

10. Next remove the chopper lid from the chopper bowl. In order to do this, you will have to turn the chopper lid anticlockwise to unlock it from the chopper bowl.

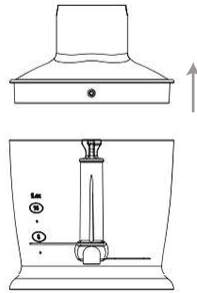

IMPORTANT: Handle blades with care to avoid cuts. Failure to do so can result in injury.

HOW TO USE YOUR OPTIMUM STICK BLENDER

USING THE DOUBLE BEATER

1. Attach both beaters to the double beater attachment.

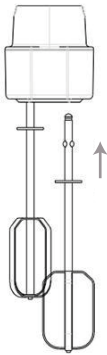

2. Insert the double beater attachment into the motor unit and turn until it locks into place.

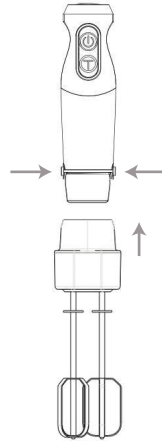

3. Plug the power cord into an outlet and turn it on.

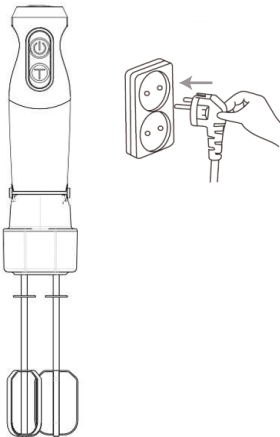

4. Use the speed control to select a speed from 1 to 5 depending on your ingredients.

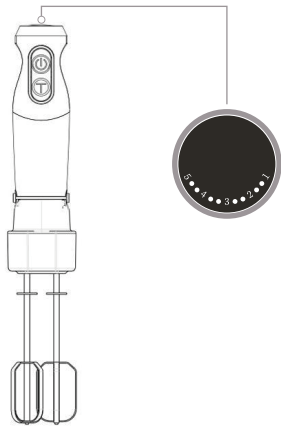

HOW TO USE YOUR OPTIMUM STICK BLENDER

USING THE DOUBLE BEATER

- 5.** Place the beaters into the bowl and press the power button to start mixing.

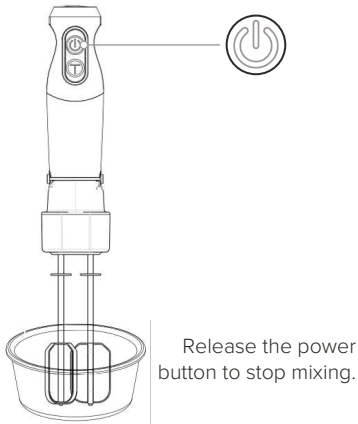

- 6.** Turn off and unplug motor unit, then press the release buttons to remove double beater attachment and detach both beaters.

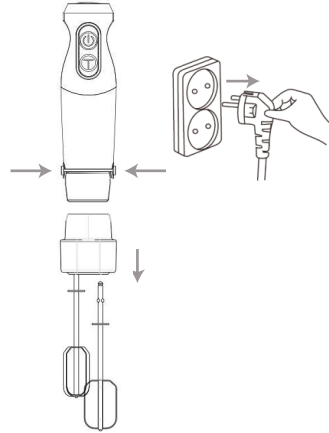

IMPORTANT: Double beater attachment should not be submerged beyond the level of the beater stems.

HOW TO USE YOUR OPTIMUM STICK BLENDER

USING THE POTATO MASHER

1. Attach the potato masher attachment to the motor unit and turn until it locks into place.

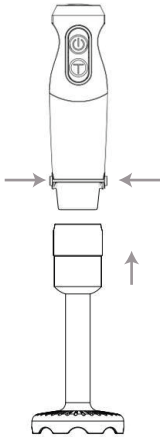

2. Plug the power cord into an outlet and turn it on.

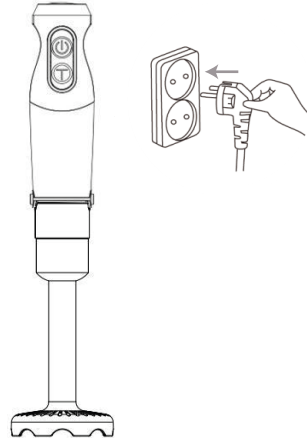

3. Use the speed control to select a speed from 1 to 2 depending on your mashing needs.

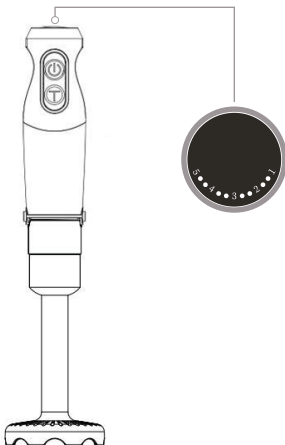

4. Insert the potato masher attachment into the bowl with boiled potatoes. Begin mashing by pressing the power button.

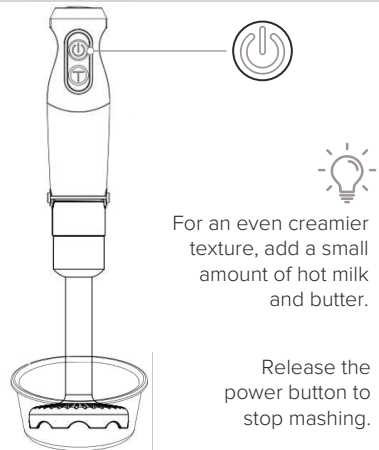

HOW TO USE YOUR OPTIMUM STICK BLENDER

USING THE POTATO MASHER

5. Turn off and unplug the motor unit, then press the release buttons to remove potato masher attachment.

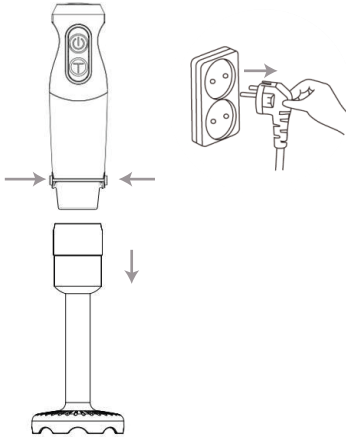

IMPORTANT: Handle blades with care. To remove potato masher blades, turn them clockwise. To secure the blades, rotate them counterclockwise.

HOW TO USE YOUR OPTIMUM STICK BLENDER

USING THE 1,25L CHOPPER

(*OPTIONAL ATTACHMENT - Available for purchase via our website)

- 1. Disc/Grinding Blade:** Suitable for grating fruits, vegetables, and soft cheeses. (maximum of 500g)
- 2. Shredder/Slicing Blade:** Use for shredding or slicing potatoes, carrots, cucumbers, and more.
- 3. Grating Blade:** Ideal for grating carrots, soft cheese, celery, and other foods.



Disc/
Grinding
Blade



Shredder/
Slicing
Blade



Grating
Blade



ASSEMBLY INSTRUCTIONS:

Insert Blade: Slide the blade "S" into the blade holder disc.

Attach Spindle Drive: Place the spindle drive onto the spindle in the center of the bowl.

Secure Blade Holder: Attach the blade holder disc onto the spindle drive.

Attach Lid Adapter: Place the blender lid adapter onto the lid.

Lock Lid: Position and secure the lid firmly.

OPERATION GUIDE

ATTACHMENT	INGREDIENTS	SPEED	TIME
Hand blender	Baby foods	3-4	30 seconds
	Cooked meats	5	20 seconds
	Cooked veggies	3	30 seconds
	Dips	1-3	20 seconds
	Liquefying fruits	5	30 seconds
	Milkshakes	5	20 seconds
	Sauce	4	20 seconds
	Smoothies	5	20 seconds
	Soups	3-5	30 seconds
Chopper	Breadcrumbs	4	30 seconds
	Cheeses	5	20 seconds
	Eggs	Turbo	2-4 pulses
	Fruits	1-3	15 seconds
	Herbs	5	30 seconds
	Meats	3	20 seconds
	Vegetables (Onions, etc)	3-5	15 seconds
Double beater	Batters	1-3	60 seconds
	Cream	5	60 seconds
	Egg whites	5	60 seconds
	Mayonnaise	4	60 seconds
	Mousse	4	60 seconds
	Sauce	1-2	60 seconds
	Vinaigrette	5	30 seconds
Potato masher	Boiled potatoes	1-2	60 seconds
	Boiled veggies	1-2	60 seconds

TURBO

After securing any attachment to the motor unit, press and hold the turbo button. The blender will run at high speed and will stop as soon as you release the turbo button. This function is perfect for quickly blending tougher ingredients and achieving finer consistencies.

CLEANING

1. Unplug the motor unit before cleaning.
2. Remove attachments with the release buttons.
3. Wipe the motor unit with a damp cloth. Do not immerse the motor unit in water.
4. Wipe the power cord and storage base with a soft dry cloth.
5. Wash the blender attachment, chopper lid, chopper S blade, chopper bowl, beaters, double beater attachment, potato masher attachment in hot, soapy water using a mild dish soap.
6. Avoid using abrasive detergents, cleansers and harsh brushes like steel wool.
7. Rinse attachments well and dry thoroughly with a soft dry cloth.

IMPORTANT: Attachments are not dishwasher safe.

TROUBLESHOOTING

PROBLEM	POTENTIAL CAUSES	SOLUTION
<p>Motor unit does not power on or start.</p>	<p>Attachments not properly secured.</p> <p>No power.</p>	<p>Please ensure the attachment is securely clicked into place.</p> <p>Check motor unit is plugged in.</p> <p>Check the circuit breaker in your home.</p> <p>If none of the above resolve the issue, contact after sales support.</p>
<p>Motor unit is getting hot.</p>	<p>Motor unit might have been operated for an extended period.</p> <p>Motor unit could have been handling a heavy load.</p> <p>Motor unit might have been placed near a heat source.</p>	<p>Allow the motor unit to cool completely. Refer to operation times.</p> <p>Some heat is normal during use. Avoid leaving the motor unit in direct sunlight.</p> <p>Keep motor unit in a cool place.</p>
<p>Ingredients in the bowl aren't blending.</p>	<p>Motor unit might be overloaded.</p> <p>Ingredient pieces are too large.</p> <p>Chopping speed may not be suitable for ingredients.</p>	<p>Process ingredients in smaller batches.</p> <p>Chop ingredients into smaller pieces and try again.</p> <p>Pulse ingredients, then mix on higher speed.</p>
<p>Blending causes splashes.</p>	<p>Blades are rotating at high speed.</p>	<p>Cover blades with mixture before starting to blend.</p> <p>Use a deeper bowl.</p> <p>Start with a lower speed then increase to a higher speed.</p>

PRODUCT SPECIFICATIONS

Product Name	Optimum Stick Blender
Model	STB1000
Voltage	220-240V
Frequency	50-60Hz
Rated Power	1000W
Net Weight	1,8kg
Gross Weight	2,15kg
Dimensions (stick blender attachment)	40,6 x 6,6cm
Dimensions (stand with parts)	23,6 x 22 x 27cm (WxDxH)



DISPOSAL

Do not dispose of this device with normal household waste. When it reaches the end of its service life, it must be taken to a designated collection point for recycling electrical and electronic equipment. The materials in this product are recyclable as indicated by their labels. By properly recycling or repurposing this device, you help protect the environment. Contact your local municipal to find out where the nearest disposal facility is located.

WARRANTY

The warranty outlined below only covers distributors of the Optimum range of appliances. Please contact your distributor for a full product warranty.

Effective as of 1st January 2014

1. Optimum® (“we”) warrants this appliance to be free from defects in materials and workmanship. As long as you use it according to this instruction book, Optimum® warrants that it will perform satisfactorily in household use for a period of 1 year.
2. Any warranties beyond this standard period are offered as extended terms by the selling distributor. This means you can only claim them through that provider.
3. We will repair, replace your appliance if any defects occur under normal use and care within this manufactures warranty period at our discretion and only if the selling distributor cannot do so. This is done solely at our option with no charge for parts. This warranty does not extend to any accessories whether included or purchased separately. If your distributor determines that your appliance has a major fault, they may offer a replacement at their own discretion.
4. If your appliance needs repair while it is under warranty and your distributor cannot provide the repairs, you are responsible for the cost of returning it to us (or an approved service provider), and also for the cost returning it back to you.
5. Whilst your appliance is in transit, you assume all risk for it. The warranty does not cover any further damage during transportation.
6. You must ensure that you properly package your appliance when you return it to avoid any damage to it during transit.
7. To enable us to process your warranty claim, ensure you include an explanation of any problem. We will not look for faults for you and will only repair described faults as covered under warranty.
8. This full warranty is void if your appliance has been subjected to abuse, negligence, accident, alteration, failure to follow operating instructions, or exposed to abnormal or extreme conditions.
9. Cosmetic changes that do not affect performance will not be consider defects or fall under this warranty. These changes include discolouration of any parts of your appliance, or the effects of using abrasive cleaners. The warranty does not cover cleaning or removing any food products from your appliance, or repairing any damage caused by allowing them to build up.
10. This warranty does not cover normal wear and tear on your appliance or its parts.
11. This warranty does not cover any defect caused by an accident, misuse, abuse, improper installation or operation, lack of reasonable care, unauthorized medication, loss of parts, tampering or attempted repair by anyone we have not authorized to make repairs.
12. The warranty will not apply if the damage, malfunction of failure results from alterations, accident, misuse, abuse, fire, liquid spillage, maladjustment of customer controls, use on an incorrect voltage, power surges and dips thunderstorm activity, acts of God, voltage supply problems, tampering or unauthorized repairs by any persons, use of defective or incompatible, exposure to abnormally corrosive conditions or entry by any insect, vermin or foreign object in the product.
13. The warranty does not cover damage from using your appliance with an alternate power source (e.g. solar, inverter, generator, etc). We do not recommend using these devices to power your appliance.
14. You must keep your purchase docket and receipt as both proof of purchase, and proof of the date on which you made the purchase. You will need to present your purchase docket or receipt when making a claim under this warranty.
15. If you do not present your receipt of purchase, this warranty is invalid. Consumer Law allows us to request reasonable proof of purchase to service a warranty claim.
16. This warranty does not imply, intend to or detract from any consumer rights listed in, and able to be enforced from, Regulated Consumer Law. If any condition is found to be breach of the Consumer Law, only that single condition shall be void, and all other conditions will remain in place.

CONTACT US

Athena Solutions Pty Ltd
(Froothie Australia)
7/74-80 Melverton Drive
3803 Hallam, VIC
Australia

1300 309 900

+61 3 8609 2210

support@froothie.com.au

www.froothie.com.au

